

Microcontroller

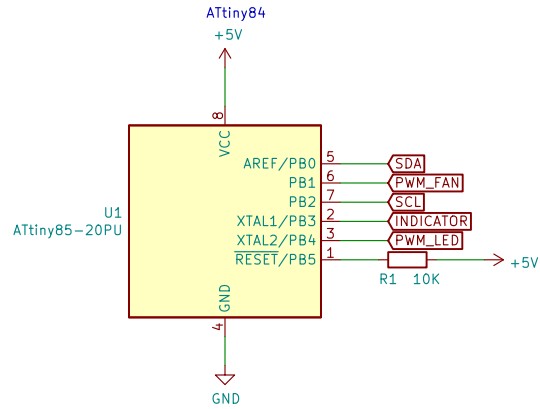

I2C

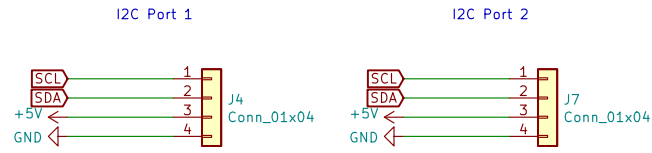

Pullup Resistors for I2C

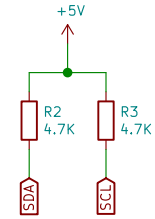

Power

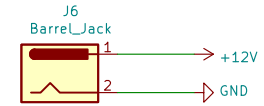
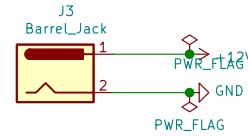
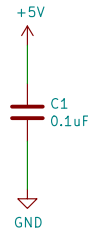

LED Driver

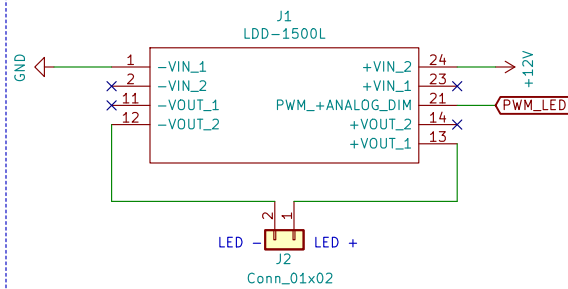

Fan

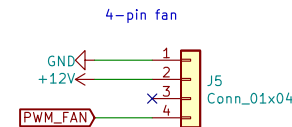

Indicator LED

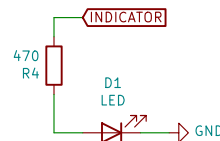

plampkin@wisc.edu
 Philip Lampkin
 Gellman Group
 Department of Chemistry
 University of Wisconsin-Madison

Sheet: /
 File: driver.sch

Title: Digital Photoreactor Driver

Size: USLetter | Date: 2021-01-19
 KiCad E.D.A. kicad 5.1.8+dfsg1-1+b1

Rev: 1.0.0
 Id: 1/1